

MapIT® G2 SPP PCB Upgrade Instructions

MapIT G2 Ready Panel

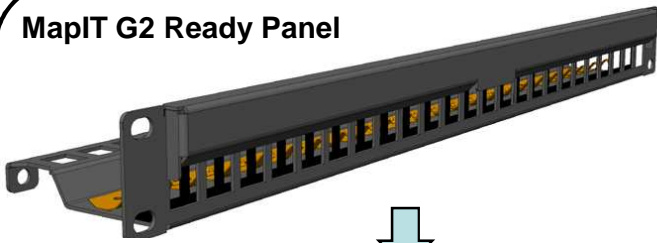

MapIT G2 Smart Panel

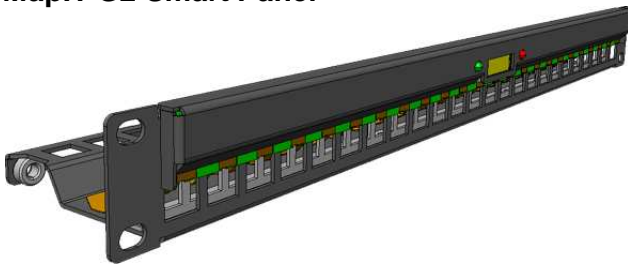

Upgrade Kit:
M-SPP-PCBA-24

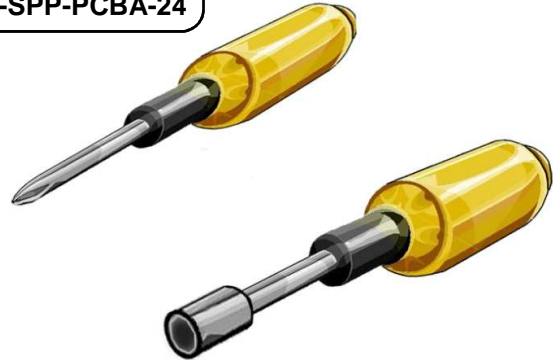

5/16th Nut Driver
(or wrench)

Tools

Optional: Detach panel from rack if necessary - pull out ~ 3-4 in. (75-100mm) to access nuts. Note: Open end wrench may be required in place of nut driver.

BACK

X 4

5/16th

FRONT

1

2

X 4

Alignment pins

Important: Insert alignment pins securely before tightening nuts.

X 3

5/16th

3

Gasket

PCB

5/16th Nuts X 3

Note: Do not tighten nuts yet see next step.

4

MapIT® G2 SPP PCB Upgrade Instructions

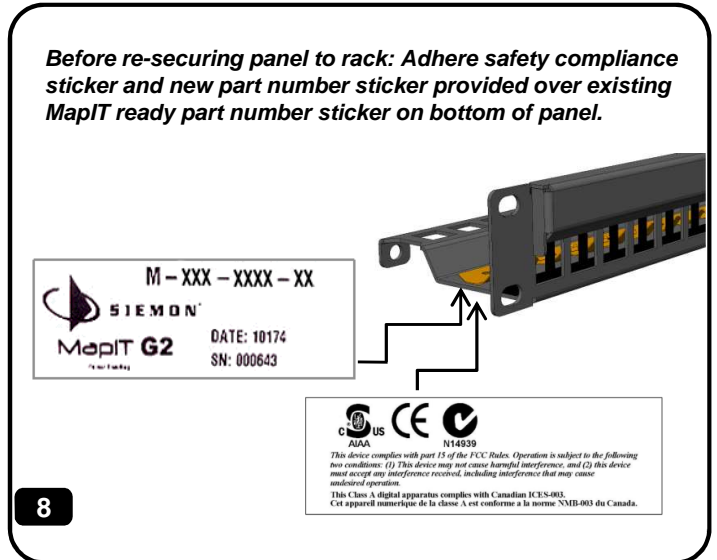
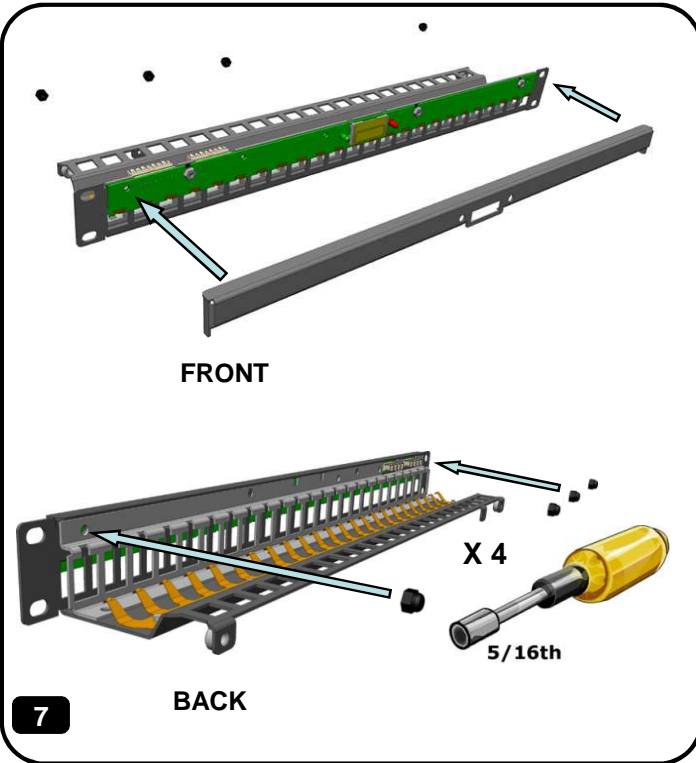
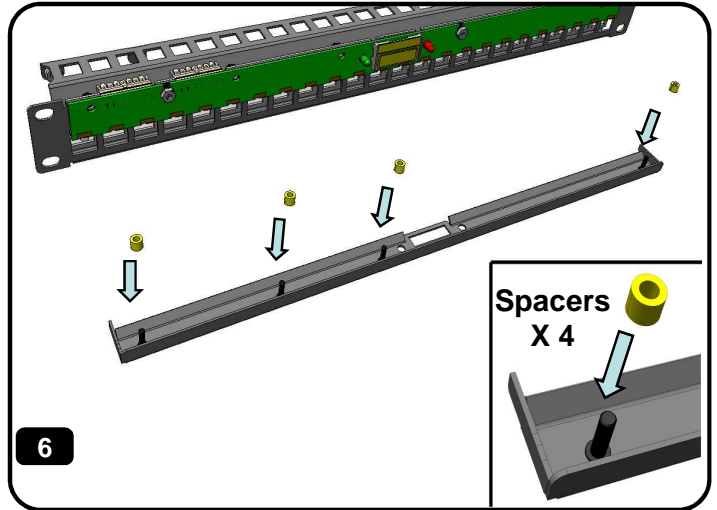
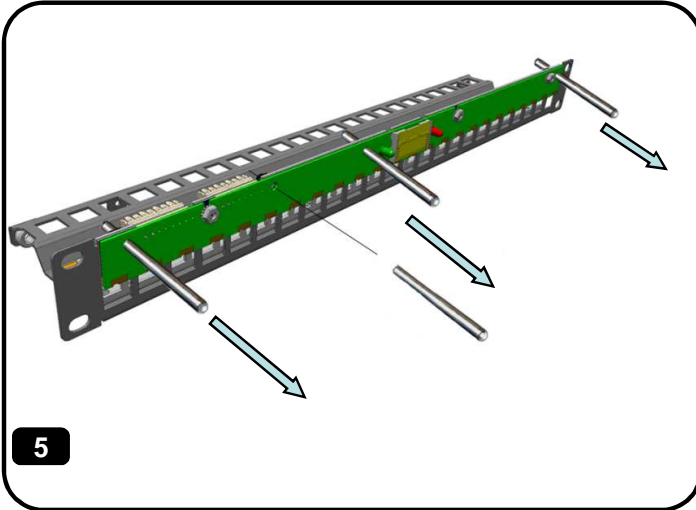

To ensure you have the latest revision to this document, please visit:

www.siemon.com/us/download/installation.asp#mapit

For additional setup and control cable connections, click on pdf:
MapIT G2 Control Panel to SPP:

Comply with the following for safe installations:

- Use caution when installing or modifying telecommunications circuits.
- Never touch uninsulated wire terminals unless the circuit has been disconnected.
- Never install this device in a wet location.
- Never install wiring during a lightning storm.
- Wear grounding strap to prevent static discharge

Global Headquarters
Watertown, Connecticut USA
Tel: (1) 866-548-5814



www.siemon.com

For a complete listing of our global offices visit our web site